

1CH ADJ Current-Limited Power Distribution Switch

Features

- Single-Channel Power Distribution Switch
- Programmable Current Limit in 0.4A~2A Output Current
- Enable polarity: Active High
- 2.4V to 5.5V Supply Range
- Under-Voltage Lockout
- -40°C to +85°C Ambient Temperature Range
- Accurate Current Limit
- 15 μ A Quiescent Current
- 80m Ω MOSFET
- Thermal-Shutdown Protection
- Built-In Soft Start
- Reverse Current Blocking (No Body Diode)
- Available in SOT23-5 Package

Applications

- Set-Top Boxes
- Wi-Fi Router/AP
- USB 3G Datacard/ USB Dongle
- High-Definition Digital TVs
- ONT Boxes
- USB Ports and Hubs, Laptops, and Desktops
- Smartphone and PDA
- MiniPCI Accessories

General Description

The RY2121 Power Distribution Switch features internal current limiting to prevent damage to host devices due to faulty load conditions. The RY2121 develops ultra-low on-resistance switch with programmable current limiting to protect the power source from over current and short circuit conditions. It integrates the over temperature protection and discharges the output capacitor during the shutdown. In case the output is pulled higher than the input voltage under the shutdown, the RY2121 can block the current flowing from the output to the input. The RY2121 is available in SOT23-5 package.

Typical Application Circuit

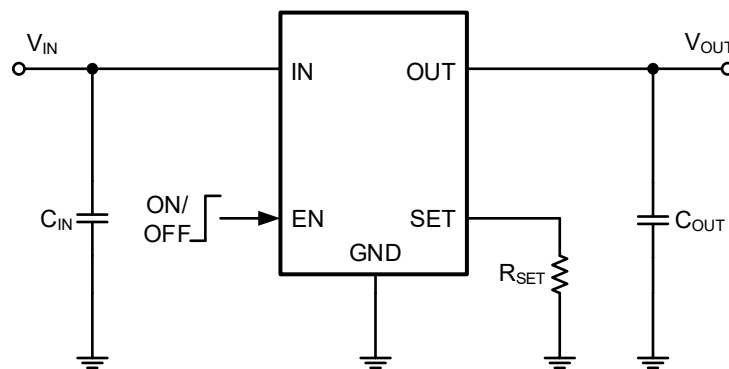

Basic Application Circuit

1CH ADJ Current-Limited Power Distribution Switch

Pin Description

Pin Configuration

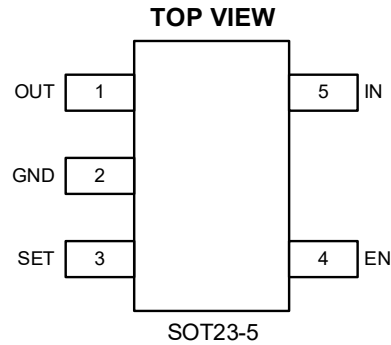

Top Marking: MEYLL (device code: ME, Y=year code, LL= lot number code)

Pin Description

Pin	Name	Function
1	OUT	Output Pin.
2	GND	Ground Pin.
3	SET	Current limit programming Pin. Connect a resistor R_{SET} from this pin to GND to program the current limit.
4	EN	ON/OFF control. Pull high to enable IC, Do not float.
5	IN	Power Supply Pin

Order Information

Marking	Part No.	Model	Description	Package	T/R Qty
ME <u>YLL</u>	70702013	RY2121	RY2121 1CH Current Limited IC, V_{IN} 2.4V-5.5V, I_{LIM} ADJ, Active High, SOT23-5	SOT23-5	3000PCS

1CH ADJ Current-Limited Power Distribution Switch

Absolute Maximum Ratings ^{(1) (2) (3)}

All Pins Voltage	-0.3V to +6V
Operating Virtual Junction (T _J)	-40°C to +150°C
Ambient Temperature Operating Range (T _A)	-40°C to +85°C
Storage Temperature Range (T _S)	-55°C to +150°C
Lead Temperature (Soldering, 10s) (T _L)	+260°C
Junction-to-ambient thermal resistance (R _{θJA})	200°C/W
Junction-to-case thermal resistance (R _{θJC})	130°C/W

Note 1: Exceeding these ratings may damage the device.

Note 2: The device is not guaranteed to function outside of its operating conditions.

Note 3: θ_{JA} is measured in the natural convection at T_A = 25°C on a low effective single layer thermal conductivity test board of JEDEC 51-3 thermal measurement standard. Pin 2 of SOT23-5 packages is the case position for θ_{JC} measurement.

Recommended Operating Conditions

Input Voltage Pin	+2.4V to +5.5V
All Other Pins	0V to +5.5V
Junction Temperature Range (T _J)	-40°C to +125°C
Ambient Temperature Range (T _A)	-40°C to +85°C

Electrical Characteristics⁽⁴⁾

(V_{IN} = 5V, C_L=1μF, per channel, T_A = 25°C unless otherwise specified)

Parameter	Symbol	Test Conditions	Min	Typ.	Max	Unit
Input Voltage Range	V _{IN}		2.4		5.5	V
Shutdown Input Current	I _{SHDN}	Open load, IC Disabled		0.6	1	μA
Quiescent Supply Current	I _Q	Open load, IC Enabled		20		μA
FET RON	R _{DS(ON)1}			80		mΩ
ENB Rising Threshold	V _{ENB(H)}		1.2			V
ENB Falling Threshold	V _{ENB(L)}				0.8	V
ENB Leakage	I _{ENB}	V _{ENB} =5.5V			1	μA
IN UVLO Threshold	V _{IN,UVLO}				2.3	V
IN UVLO Hysteresis	V _{IN,HYS}			0.1		V
Over Current Limit	I _{LIM}	R _{SET} =6.8kΩ	0.75	1.0	1.25	A
	I _{LIM(MIN)}			0.4		A
	I _{LIM(MAX)}			2		A
Turn-ON Time ⁽⁵⁾	T _{ON}	R _L =10Ω, C _L =1uF		120		μS
Turn-OFF Time ⁽⁵⁾	T _{OFF}	R _L =10Ω, C _L =1μF		10		μS
OUT Shutdown Discharge Resistance	R _{DIS}			150		Ω
Thermal Shutdown Temperature	T _{SD}			130		°C
Thermal Shutdown Hysteresis	T _{HYS}			20		°C

1CH ADJ Current-Limited Power Distribution Switch

Note 4: The device is not guaranteed to function outside its operating conditions.

Note 5: Measured from (50%) EN signal to (90%) output signal.

Typical Performance Characteristics (6) (7)

Note 6: Performance waveforms are tested on the evaluation board.

Note 7: $V_{IN} = 5V$, $C_{OUT} = 1\mu F$, $R_{SET} = 6.8k\Omega$, $T_A = +25^\circ C$, unless otherwise noted.

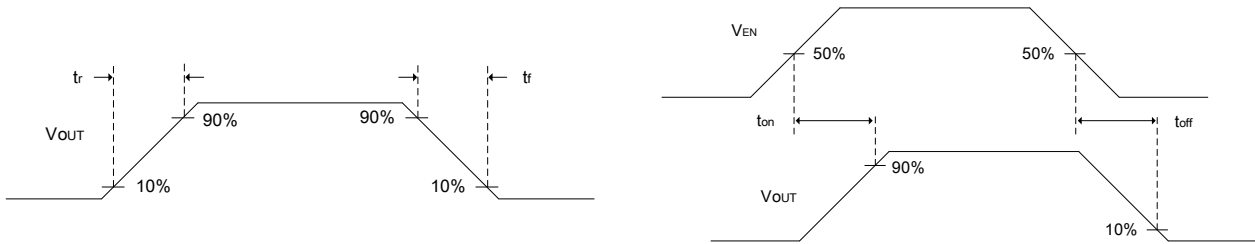
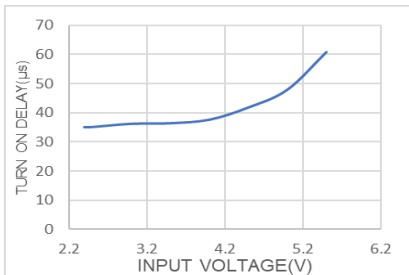

Figure 1 Tr, Tf, Ton, Toff waveforms

Turn on Delay vs. Input Voltage

$V_{EN}=5V$, $R_{LOAD}=5\Omega$



Turn off Delay vs. Input Voltage

$V_{EN}=5V$, $R_{LOAD}=5\Omega$

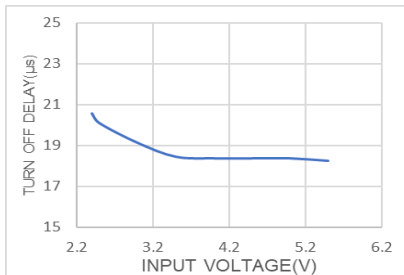

Supply Current, Output Enabled vs. Input Voltage

$V_{EN} = 5V$

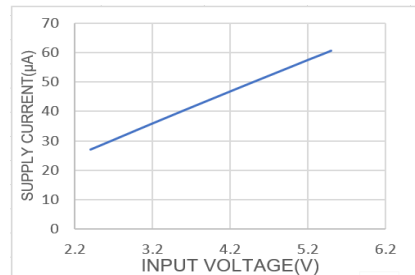

Supply Current, Output Disabled vs. Input Voltage

$V_{EN} = 0V$

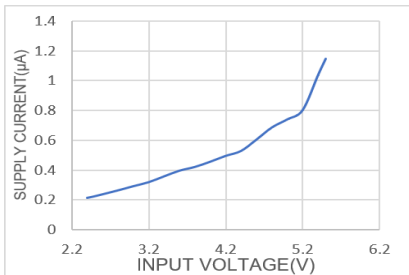

Static Drain-Source On-State Resistance vs. Input Voltage

$V_{EN} = 5V$, $I_{LOAD}=0.5A$

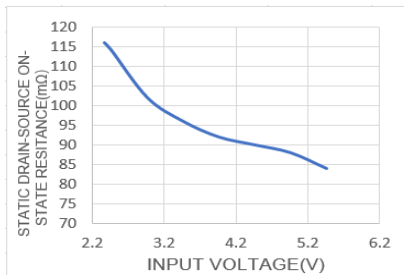

Input to Output Voltage vs. Load Current

$V_{EN} = 5V$

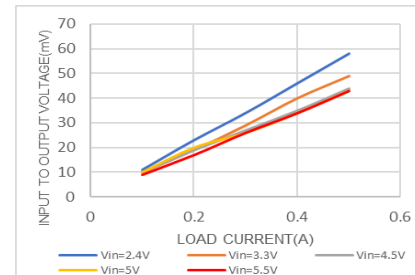

1CH ADJ Current-Limited Power Distribution Switch

Current Limit vs. Input Voltage

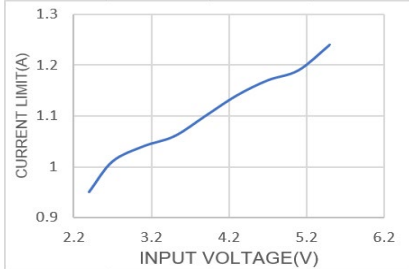

Threshold Trip Current vs. Input Voltage

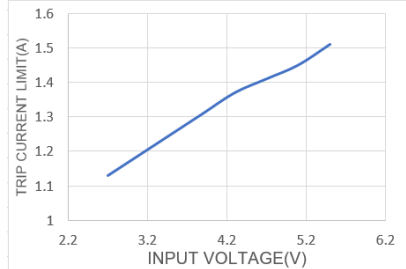

Current Limit vs. R_{SET}

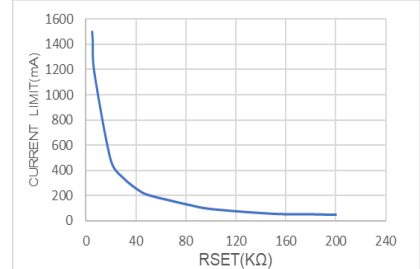

Turn on Delay Rise Time

VEN = 5V, R_{LOAD}=5Ω

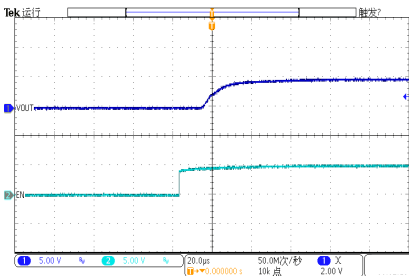

Turn off Delay Fall Time

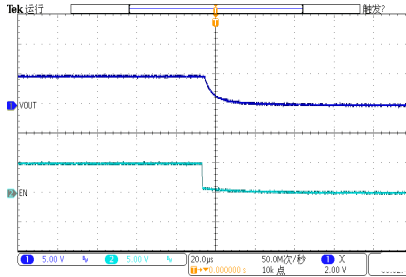

Threshold Trip Current with Ramped Load Enabled Device

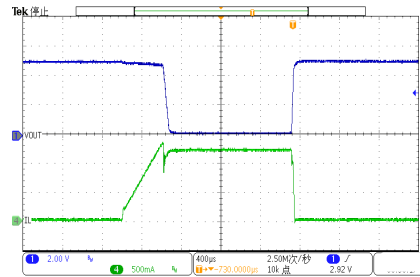

1Ω Load Connected to Enabled Device

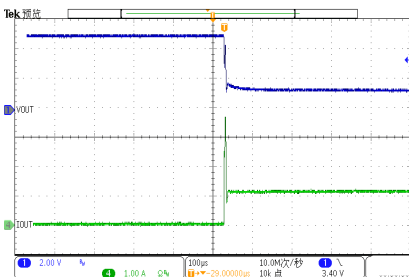

Short Circuit Current, Device Enabled into Short

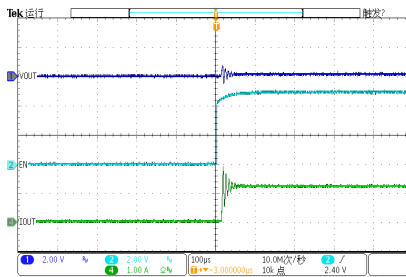

Current Limit vs. R_{SET}

I_{LIM}=0.4~1.5A

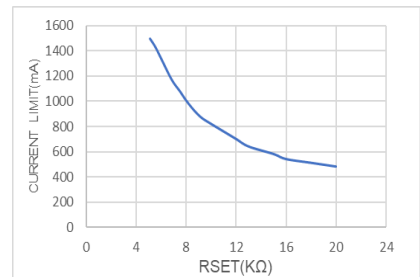

1CH ADJ Current-Limited Power Distribution Switch

Function Block Diagram

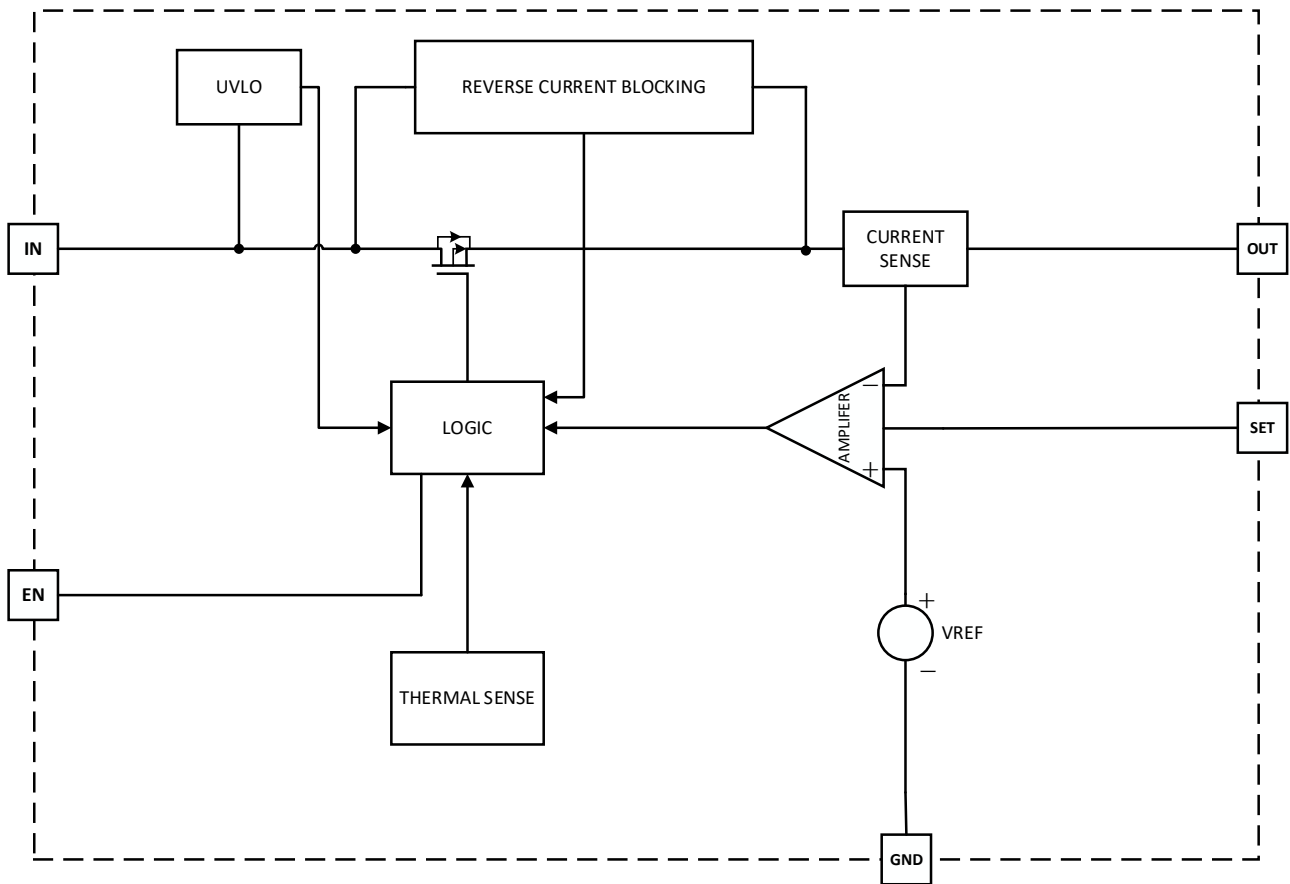

Figure 2 Function Block Diagram

1CH ADJ Current-Limited Power Distribution Switch

Functions Description

Current Limit

The RY2121 provides a constant current limit that can be programmed by an external resistor. Once the device reaches its current limit threshold, the internal circuit regulates the gate voltage to hold the current in the power MOSFET constant. Below table can be taken as a reference to choose R_{SET} to set the current limit threshold.

R_{SET} (k Ω)	Typical Current Limit (mA)
5.1	1500
5.6	1420
6.8	1180
7.5	1080
8.2	980
9.1	880
10	820
11	760
12	700
13	640
15	580
16	540
18	510
20	480
30	340
43	238
51	202
68	160
82	128
100	94
150	56
180	52
200	48

Table 1 Current Limit Threshold Setting

Over Current

When the load exceeds trip current (minimum threshold current triggering constant-current mode) or short circuited, RY2121 switches into to constant-current mode (current limit value). RY2121 will be shut down only if the overcurrent condition stays long enough to trigger thermal protection.

Trigger overcurrent protection for different overload conditions occurring in applications:

- 1) The output has been shorted or overloaded before the device is enabled or input applied. RY2121 detects the short or overload and immediately switches into a constant-current mode.
- 2) A short or an overload occurs after the device is enabled. The device switches into constant current mode after the current-limit circuit has been tripped (reached the trip current threshold). However, high current may flow for a

1CH ADJ Current-Limited Power Distribution Switch

short period of time before the current-limit circuit can react.

3) Output current has been gradually increased beyond the recommended operating current. The load current rises until the trip current threshold is reached or until the thermal limit of the device is exceeded. Once the trip threshold has been reached, the device switches into its constant-current mode.

Thermal Protection

If the current limit block starts to regulate the output current, the power loss on power MOSFET will cause the IC temperature rise. The die temperature is internally monitored until the thermal limit is reached. Once this temperature is reached, the switch will turn off to allow the chip to cool until the over temperature fault remove. The over temperature threshold is 130°C and hysteresis is 20°C.

Under-voltage Lockout (UVLO)

This circuit is used to monitor the input voltage to ensure that the RY2121 is operating correctly. This UVLO circuit also ensures that there is no operation until the input voltage reaches the minimum spec.

Reverse Current Blocking

In case the output is pulled higher than the input voltage under the shutdown, the RY2121 can block the current flowing from the output to the input. This prevents damage to devices on the input side of the RY2121 by preventing significant current from sinking into the input capacitance.

Output Discharge

RY2121 has output discharge function. It can discharge the output capacitor by internal pulldown resistance during shutdown.

1CH ADJ Current-Limited Power Distribution Switch

Package Description

SOT23-5

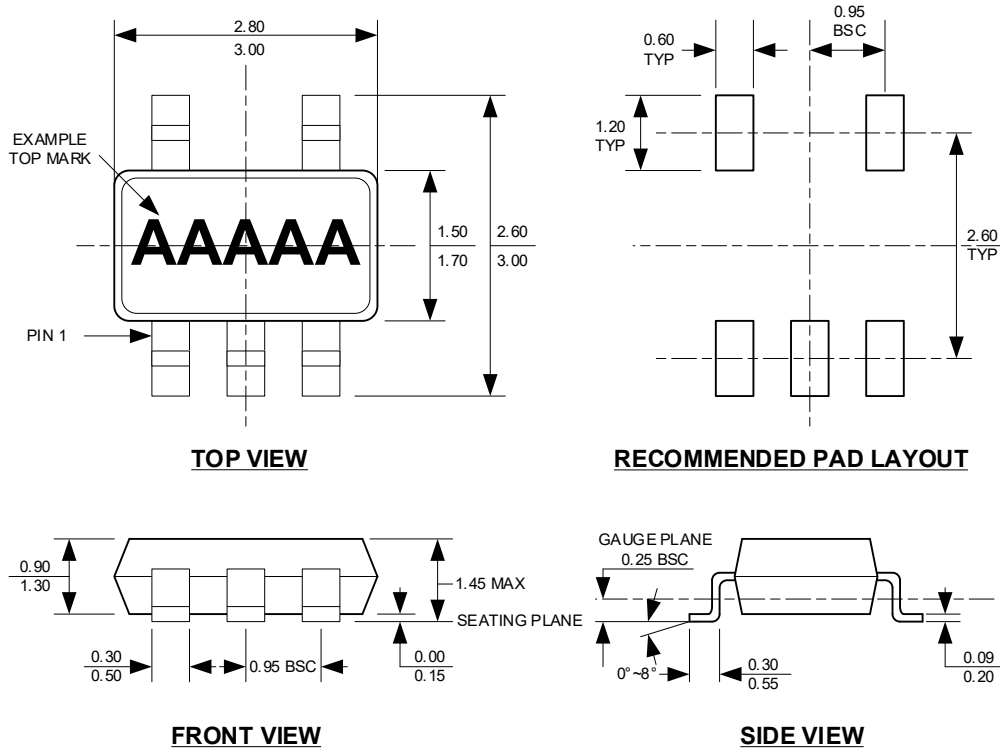

NOTE:

1. CONTROL DIMENSION IS IN INCHES. DIMENSION IN BRACKET IS IN MILLIMETERS.
2. PACKAGE LENGTH DOES NOT INCLUDE MOLD FLASH, PROTRUSIONS OR GATE BURRS.
3. PACKAGE WIDTH DOES NOT INCLUDE INTERLEAD FLASH OR PROTRUSIONS.
4. LEAD COPLANARITY (BOTTOM OF LEADS AFTER FORMING) SHALL BE 0.004" INCHES MAX.
5. DRAWING CONFORMS TO JEDEC MS-012, VARIATION BA.
6. DRAWING IS NOT TO SCALE.